

NG.1000

□ 1"1/2 - 38,1 mm

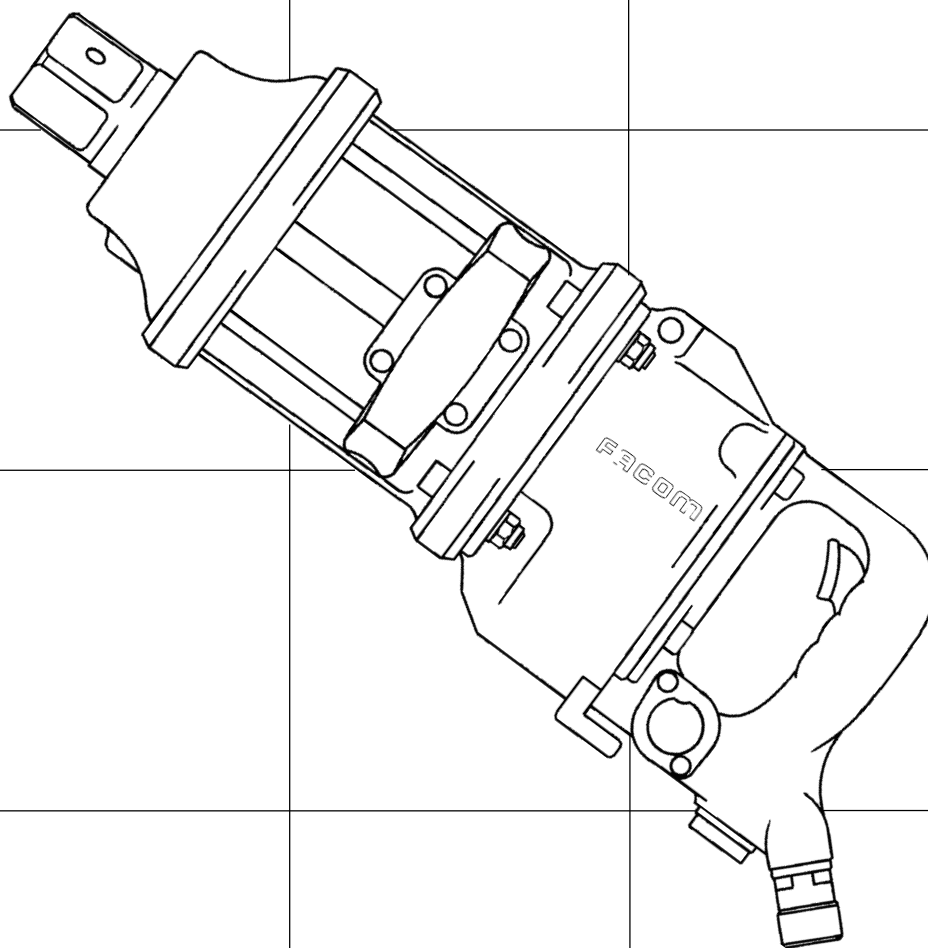

- Clé à chocs
- Impact wrench
- Schlagschrauber
- Slagmoersleutel
- Llave de impacto
- Chiave a percussione

Notice d'instructions
Instruction manual
Bedienungsanleitung
Gebruiksaanwijzing
Manual de instrucción
Istruzioni per l'utilizzo
NU-NG.1000/97

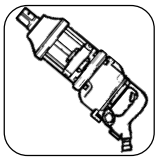

16,5 kg 500 x 195 x 216 mm **1"1/2** **55 mm** **maxi 1800 t/mn** **maxi 3000 Nm**

1/2 NPT
Ø 13 mm
1600 l/mn

1"1/2

- NG.240**
- NG.232** (1"1/2 - 2"1/2)
- NG.230** (1"1/2 - 1")
- NG.210 / 215**
- NG.46-----120**

104 dB(A)

20 m/s²



Inverseur
Reverser
Umschalter
Omkeerschakelaar
Engranaje inversor
Invertitore

1500 **3000 Nm**

NG.1000

GARANTEE
GARANTEE
GARANZIA
GARANTIA

1 ANNO
1 YEAR
1 ANOS

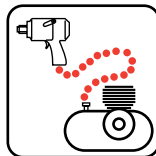

15 bars maxi/20°C
10 bars maxi/60°C
2,5 m³/mn mini

6 - 10 bars

N.565 **N.626** **N.616** **NS.557**

NG.1000



BA.44
GA.44
GA.46
GA.48
GA.50

MINI 3000 Nm

Porter des lunettes de sécurité
Wear eye protectors
Schutzbrille tragen
Een veiligheidsbril dragen
Utilizar gafas de seguridad
Portare gli occhiali di sicurezza



Pour garder la machine en bon état, remplacer les pièces d'usure toutes les 200 heures d'utilisation.
To keep the machine in proper working order, change wear parts after 200 hours to use.
Um die Maschine in gutem Zustand zu erhalten, Gebrauchsteile alle 200 Betriebsstunden austauschen.
Om deze machine in goede staat te houden, dienen de aan slijtage onderhevige onderdelen na 200 uren gebruik te worden verwisseld.
Para mantener la maquina en buen estado, cambiar las piezas de desgaste despues de 200 horas de utilizacion.
Per mantenere la macchina in buono stato, cambiare le parti d'usura dopo 200 ore di funzionamento.

NG.1000RN1

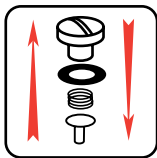

NG.1000RN1

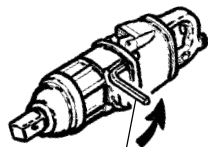
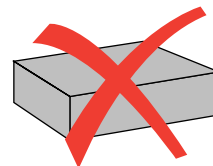

1

82.6

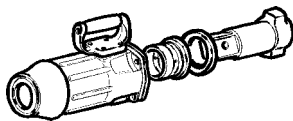

2

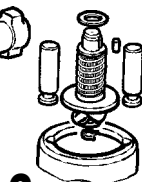

3

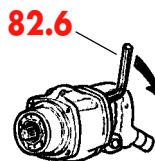

4



5



6

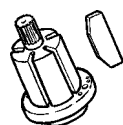
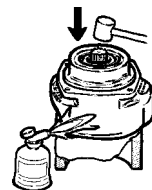

7

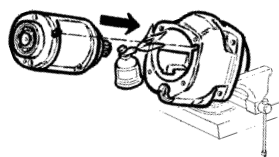

8

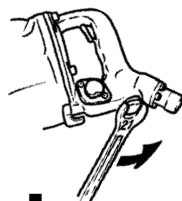

1

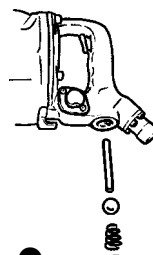

2

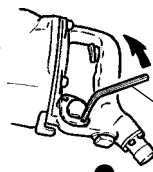

3

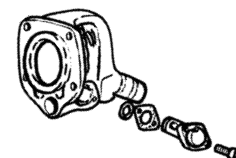

4

82.4

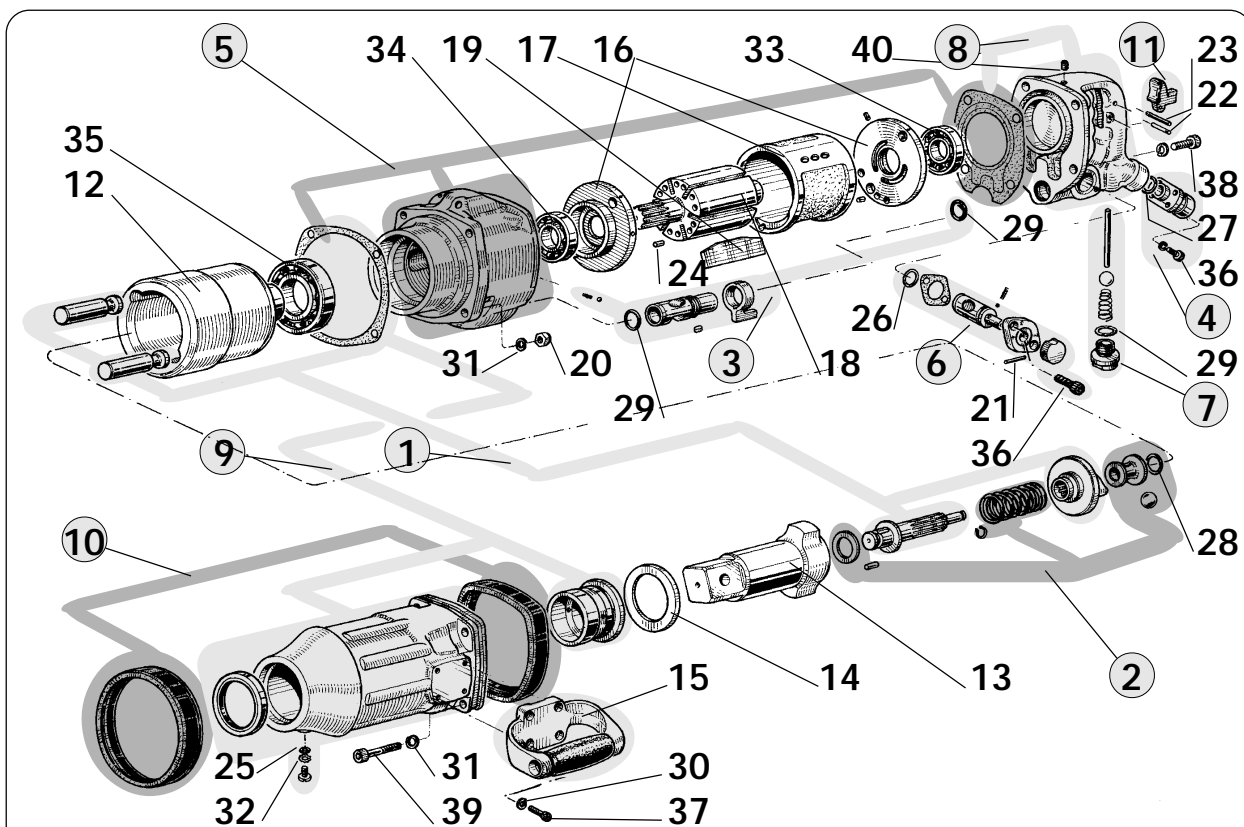

①	NG.1000RN1	⑮	NG.1000-072	⑳	BAGUE.R02000-250 (3)
②	NG.1000SE1	⑯	NM.1000-047 (2)	㉑	ROND.WL6 (4)
③	NG.1000SE2	⑰	NG.1000-041	㉒	ROND.WL8 (12)
④	NG.1000SE3	⑱	NM.1200-044	㉓	ROND.DEC,M6
⑤	NG.1000SE4	⑲	NM.1200-046J6	㉔	ROULEMENT.6205
⑥	NG.1000SE5	㉒	ECROU.Nylstop,8x100 (4)	㉕	ROULEMENT.6205Z
⑦	NG.1000SE6	㉓	GOUPE,3-22	㉖	ROULEMENT.6208Z
⑧	NG.1000SE7	㉔	GOUPE,3-25	㉗	VIS.CHC,M5-12 (6)
⑨	NG.1000SE8	㉕	GOUPE,3-28	㉘	VIS.CHC,M6-18 (4)
⑩	NG.1000SE9	㉖	GOUPE,5-10 (3)	㉙	VIS.CHC,M8-22 (4)
⑪	NG.1000SE10	㉗	BAGUE.R00607-178	㉚	VIS.CHC,M8-40 (4)
⑫	NG.1000-055	㉘	BAGUE.R01500-250		
⑬	NG.1000-059	㉙	BAGUE.R01600-250		
⑭	NG.1000-064	㉚	BAGUE.R01800-250		



**UNITED
KINGDOM
EIRE**

FACOM Tools LTD
Bridge Wharf - Bridge Road
CHERTSEY - SURREY KT16-8UJ
UNITED KINGDOM
☎ : (01932) 566 099
Fax : (01932) 562 653

**BELGIQUE
LUXEMBOURG**

FACOM Belgique S.A./NV
Weihoek 4
1930 Zaventem
BELGIQUE
☎ : (02) 714 09 00
Fax : (02) 721 24 11

DEUTSCHLAND

FACOM GmbH
Postfach 13 22 06 
42049 Wuppertal
Otto-Wells-Straße 9 
42111 Wuppertal
DEUTSCHLAND
☎ : (0202) 270 63 0
Fax : (0202) 270 63 50

**SUISSE
ÖSTERREICH
MAGYARORSZAG
CESHA REP.**

FACOM S.A./AG
12 route Henri-Stéphan
1762 Givisiez/Fribourg
SUISSE
☎ : (4126) 466 42 42
Fax : (4126) 466 38 54

NEDERLAND

FACOM Gereedschappen BV
Kamerlingh Onnesweg 2
Postbus 134
4130 EC Vianen
NEDERLAND
☎ : (0347) 372 334
Fax : (0347) 376 020

**UNITED
STATES**

FACOM TOOLS Inc.
3535 West 47th Street
Chicago Illinois 60632
U.S.A.
☎ : (773) 523 1307
Fax : (773) 523 2103

**ESPAÑA
PORTUGAL**

FACOM Herramientas SRL
Poligono industrial de Vallecas
C/.Luis 1º, s/n-Nave 95 - 2ºPl.
28031 Madrid
ESPAÑA
☎ : (91) 778 21 13
Fax : (91) 778 27 53

**SINGAPORE
FAR EAST**

FACOM Tools FAR EAST Pte Ltd
15 Scotts Road
Thong Teck Building # 08.01.02
Singapore 228218
SINGAPORE
☎ : (65) 732 0552
Fax : (65) 732 5609

ITALIA

U.A. FACOM Italia
Via Ronchetti 3
21041 Albizzate (VA)
ITALIA
☎ : (0331) 985 811
Fax : (0331) 985 930

**DANMARK
FINLAND
ISLAND
NORGE
SVERIGE**

FACOM NORDEN A/S
Navervej 16B
7451 SUNDS
DANMARK
☎ : (45) 971 444 55
Fax : (45) 971 444 66

FRANCE

Société FACOM
6-8, rue Gustave Eiffel
B.P.99
91423 Morangis cedex
FRANCE
☎ : 01 64 54 45 45
Fax : 01 69 09 60 93
<http://www.facom.fr>

