

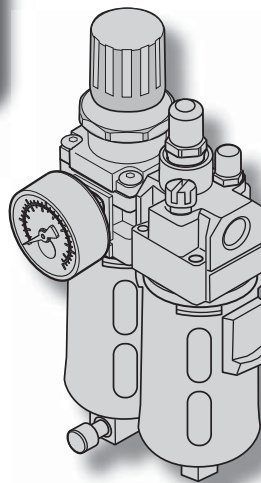

*Pro for life*



**N.580** 1/4" BSP  
**N.582** 1/2" BSP  
**N.581** 3/8" BSP



- **Filtres régulateurs lubrificateurs**
- **Filters regulators lubricators**
- **Filters-Druckminderer-Nebelöler**
- **Filters, reduceer-ventielen, olienevelaars**
- **Filtros reguladores lubricadores**
- **Filtri regolatori lubrificatori**
- **Filtros reguladores lubricadores**
- **Filtry z regulatorem i naolejaczem**
- **Filtre-Trykregulatorer -Oliesmøreapparater**
- **Ρυθμιστικά - λιπαντικά φίλτρα**

Notice d'instructions  
Instruction manual  
Bedienungsanleitung  
Gebruiksaanwijzing  
Guia de instrucciones  
Istruzioni per l'utilizzo  
Manual de instruções  
Instrukcja obsługi  
Brugsanvisning  
Οδηγίες χρήσεως



**N.580**  
829943

**N.582**  
829960

**N.581**  
829951

NU-N.FRL/0309



	P MINI	P MAXI		Q <sub>n</sub>	T°						
	bar/psi	bar/psi	μ	NI/mn	°C / °F	" BSP	Ø mm	A mm	B mm	C mm	Kg
<b>N.580</b>	1,5/22	12/174	25	550	+5°C / +41°F	1/4 ⇒ 1/4	40	172	92	86	0,485
<b>N.581</b>	1,5/22	12/174	25	1800		3/8 ⇒ 3/8	40	218	123	102	0,88
<b>N.582</b>	1,5/22	12/174	25	3000	+60°C / +149°F	1/2 ⇒ 1/2	40	275	156	118	1,83

**Max. 12 bars**  
**Min. 1,5 bar**

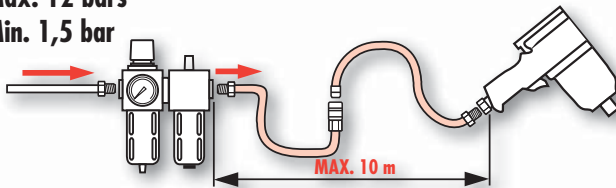

FR- Solvants interdits.  
 EN- Never use solvents.  
 DE- Verbot von Lösemitteln.  
 NL- Gebruikt nooit oplosmiddelen.  
 ES- Prohibidos los disolventes.  
 IT- E' vietato l'uso di solventi.  
 PO- Solventes proibidos  
 PL- Rozpuszczalniki zabronione  
 DK- Solvents forbudt  
 GR- Διαλύτες απαγορεύεται

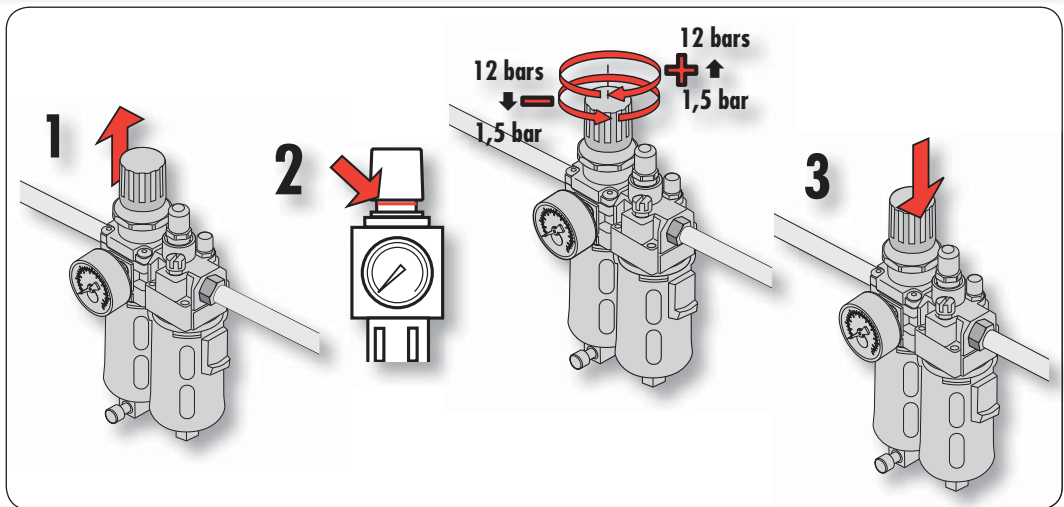

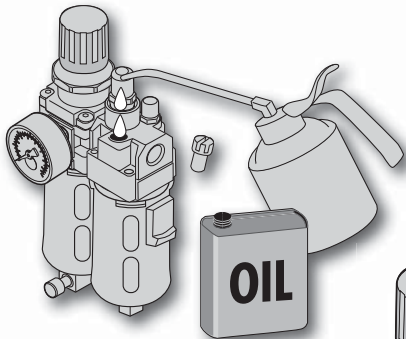

**NS.557**

FR- Huile recommandée: Viscosité Engler à 50°C : 2 à 2,5  
 EN- Recommended oil Engler viscosity 2 to 2.5 at 50°C  
 DE- Zulässige Öl: Engler-Viskosität bei 50°C: 2 bis 2,5  
 NL- Aanbevolen olie: Engler viscositeit bij 50°C: 2 tot 2,5  
 ES- Aceite recomendado: Viscosidad Engler a 50°C: entre 2 y 2,5  
 IT- Olio raccomandato: Viscosità Engler a 50°C: da 2 a 2,5  
 PO- Óleo recomendado: Viscosidade Engler a 50°C: 2 a 2,5  
 PL- Zalecany olej: Lepkość Englera przy 50°C: 2 do 2,5  
 DK- Anbefalet olie: Engler-viskositet ved 50°C: 2 til 2,5  
 GR- Προτεινόμενο λάδι: Με ιζώδες Engler στους 50°C: 2 έως 2,5

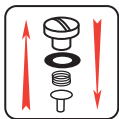
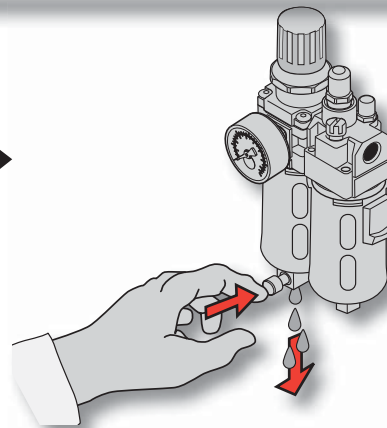
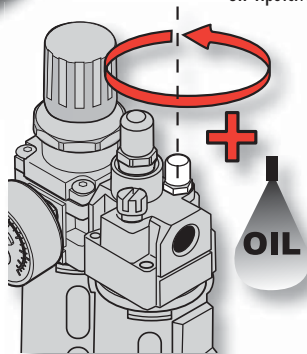

**N.580 - N.581 - N.582**

**N.580MA**

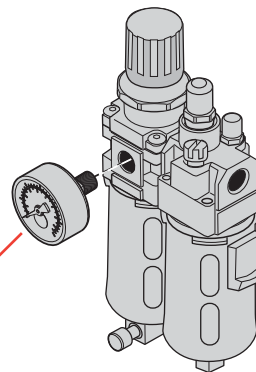

**BELGIQUE  
LUXEMBOURG** FACOM Belgie B.V.B.A.  
Egide Walschaertsstraat 14-16  
2800 MECHELEN  
BELGIQUE  
☎ : +32 (0) 15 47 39 35  
Fax : +32 (0) 15 47 39 71

**NETHERLANDS** FACOM Gereedschappen BV  
Martinus Nijhofflaan 2  
2624 ES DELFT  
P.O. BOX 1007. 2600 BA Delft  
NETHERLANDS  
☎ : 0800 236 236 2  
Fax : 0800 237 60 20

**DANMARK  
FINLAND  
ISLAND  
NORGE  
SVERIGE** FACOM NORDEN  
Nordre Strandvej 119B  
3150 HELLEBÆK  
DENMARK  
☎ : +45 49 76 27 77  
Fax : +45 49 76 27 66

**SINGAPORE  
FAR EAST** FACOM TOOLS FAR EAST  
N° 25 Senoko South Road  
Woodlands East Industrial Estate  
Singapore 758081  
SINGAPORE  
☎ : (65) 6752 2001  
Fax : (65) 6752 2697

**DEUTSCHLAND** FACOM GmbH  
Stanley Deutschland GmbH  
Otto-Hahn-Straße 9  
42369 Wuppertal  
DEUTSCHLAND  
☎ : +49 202 69 819-329  
Fax : +49 202 69 819-350

**SUISSE  
ÖSTERREICH  
MAGYARORSZAG  
ČESKÁ REP.** FACOM WERKZEUGE GMBH  
Ringstrasse 14  
8600 DÜBENDORF  
SUISSE  
☎ : 41 44 802 8093  
Fax : 41 44 802 8091

**ESPAÑA  
PORTUGAL** FACOM Herramientas S.L.  
Poligono industrial de Vallecas  
C/Luis 1º, s/n-Nave 95 - 2ªPl.  
28031 Madrid  
ESPAÑA  
☎ : +34 91 778 21 13  
Fax : + 34 91 380 65 33

**UNITED  
KINGDOM  
EIRE** FACOM-UK  
Europa view  
SHEFFIELD BUSINESS PARK  
Europa link  
SHEFFIELD S9 1 XH  
ENGLAND  
☎ : (44) 114 244 8883  
Fax : (44) 114 273 9038

**ITALIA** SWK Utensilerie S.r.l.  
Via Volta 3  
21020 Monvalle (VA)  
ITALIA  
☎ : (0332) 790 381  
Fax : (0332) 790 307

**POLSKA** FACOM Tools Polska Sp. zo.o.  
ul.Modlińska 190  
03-119 Warszawa  
POLSKA  
☎ : (48 22) 510-3627  
Fax : (48 22) 510-3656

**FRANCE & INTERNATIONAL**

FACOM S.A.S.  
6-8, rue Gustave Eiffel B.P.99  
F-91423 Morangis cedex  
FRANCE  
☎ : 01 64 54 45 45  
Fax : 01 69 09 60 93  
<http://www.facom.com>

En France, pour tous renseignements techniques sur l'outillage à main, téléphonez au : 01 64 54 45 14

