

# V.950

□ 1/2" - 12,7 mm

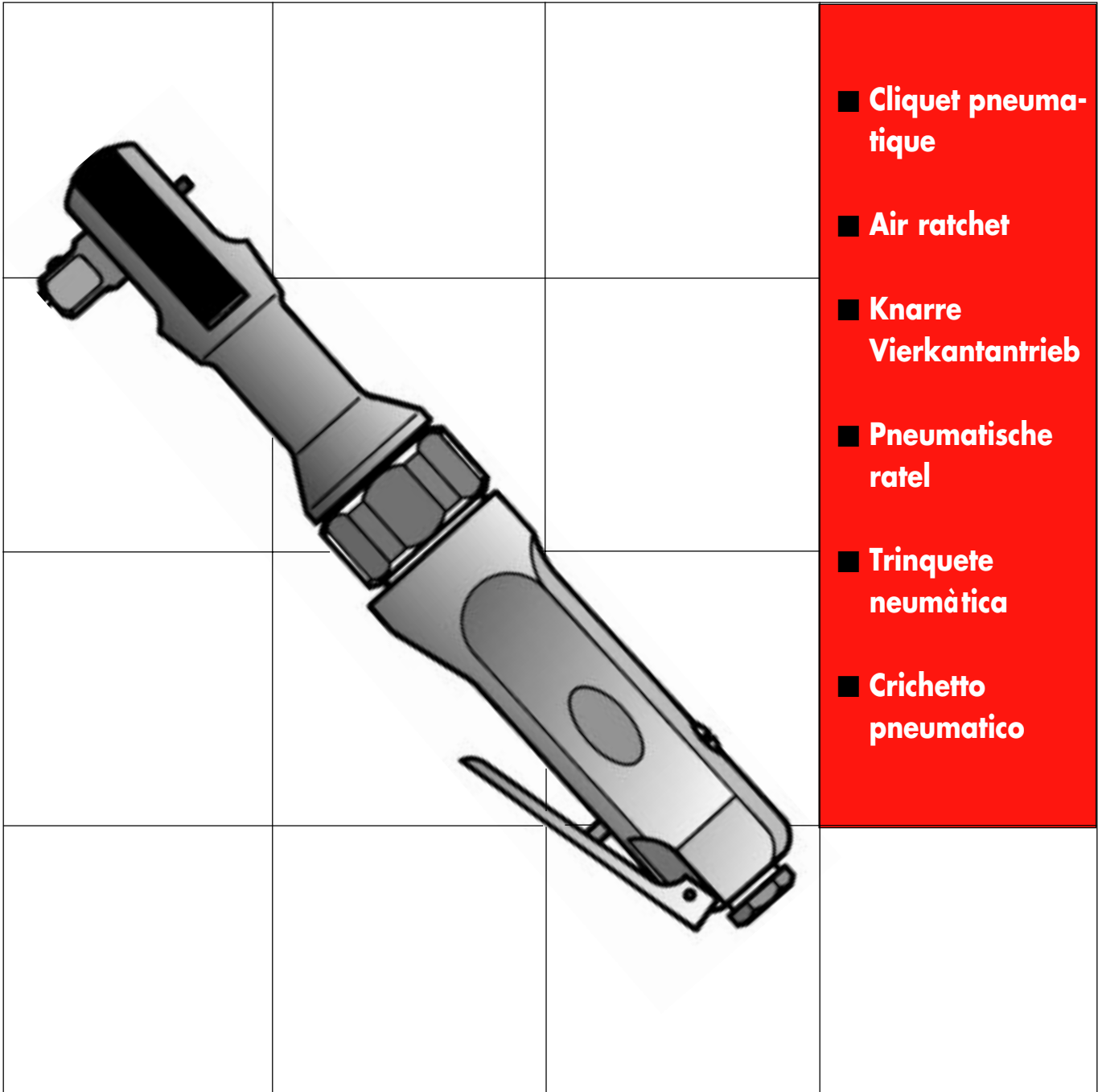

■ Cliquet pneumaticque

■ Air ratchet

■ Knarre  
Vierkantantrieb

■ Pneumatische ratel

■ Trinquete neumàtica

■ Cricchetto pneumatico

Notice d'instructions  
Instruction manual  
Bedienungsanleitung  
Gebruiksaanwijzing  
Manual de instrucción  
Istruzioni per l'utilizzo

**NU-V.950/98**



1,1 kg

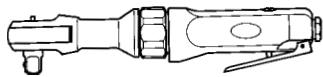

1/2"

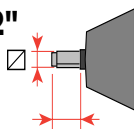

15,5 mm

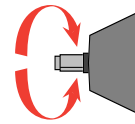

maxi 160 t/mn

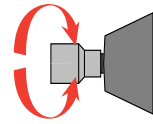

maxi 75 Nm

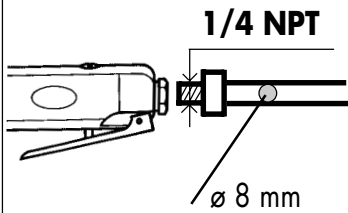

1/4 NPT

ø 8 mm

410 l/mn / 6 bar

1/2"

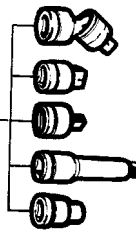

S.240A  
 S.230 (1/2" - 3/8")  
 S.232A (1/2" - 3/4")  
 S.206/208/210/215/217  
 S.211 / S.213  
 S.12HL/LA-----32HL/LA  
 S.1/2"LA-----1"1/4LA  
 S.8/8H-----34/34H  
 S.3/8"/3/8"H-----1"1/4  
 S.236 / S.237



92 db(A)



3,1 m/s2



Inverseur  
 Reverser  
 Umschalter  
 Omkeerschakelaar  
 Engranaje inversor  
 Invertitore

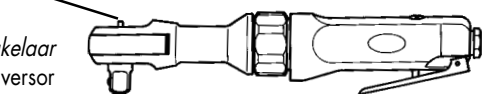

V.950

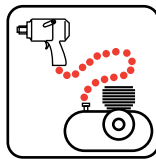
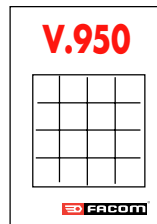

15 bar maxi/20°C  
 10 bar maxi/60°C  
 1 m3/mn mini

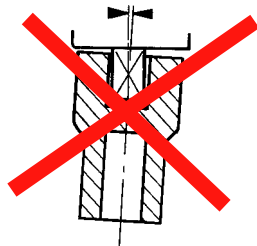
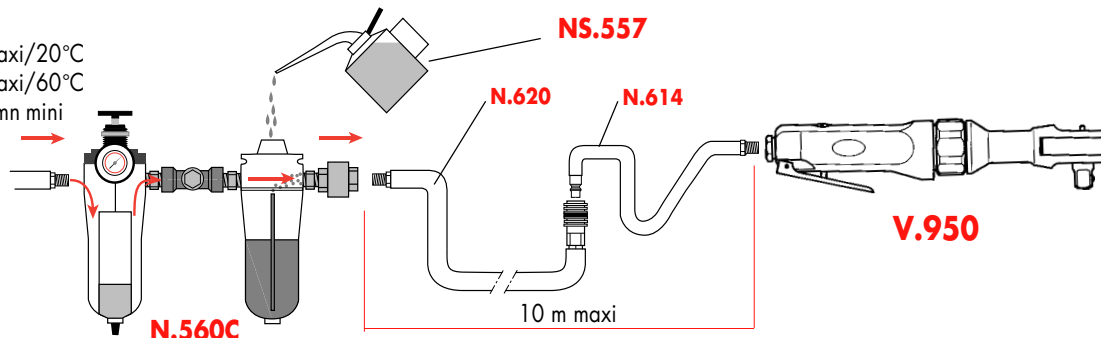

75 Nm

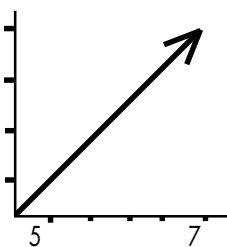

BAR



Porter des lunettes de sécurité  
 Wear eye protectors  
 Schutzbrille tragen  
 Een veiligheidsbril dragen  
 Utilizar gafas de seguridad  
 Portare gli occhiali di sicurezza



Pour garder la machine en bon état, remplacer les pièces d'usure toutes les 200 heures d'utilisation.  
 To keep the machine in proper working order, change wear parts after 200 hours to use.  
 Um die Maschine in gutem Zustand zu erhalten, Gebrauchsteile alle 200 Betriebsstunden austauschen.  
 Om deze machine in goede staat te houden, dienen de aan slijtage onderhevige onderdelen na 200 uren gebruik te worden verwisseld.  
 Para mantener la maquina en buen estado, cambiar las piezas de desgaste despues de 200 horas de utilizacion.  
 Per mantenere la macchina in buono stato, cambiare le parti d'usura dopo 200 ore di funzionamento.

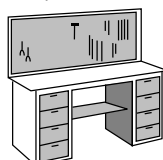
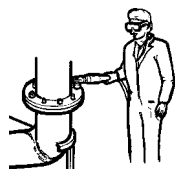

V.950RN1

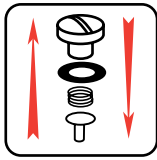

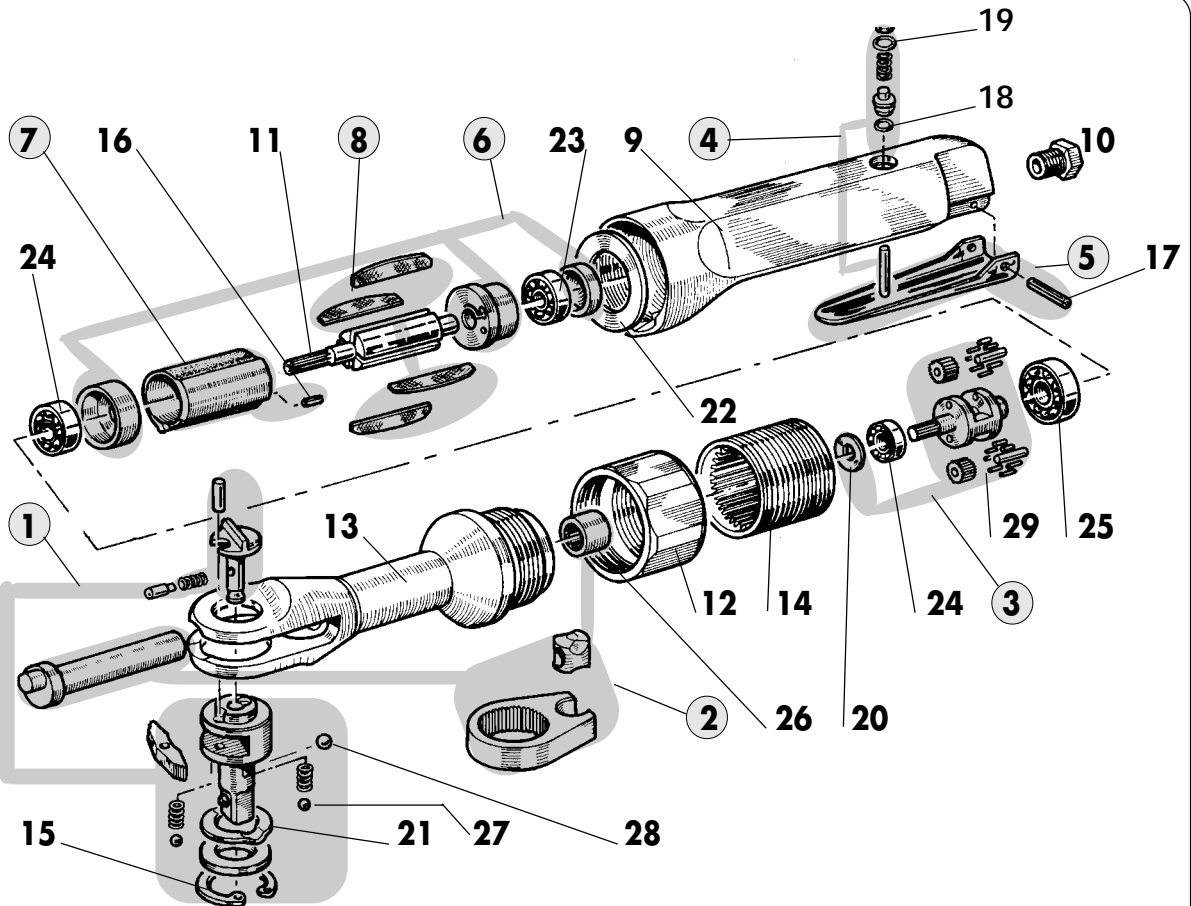
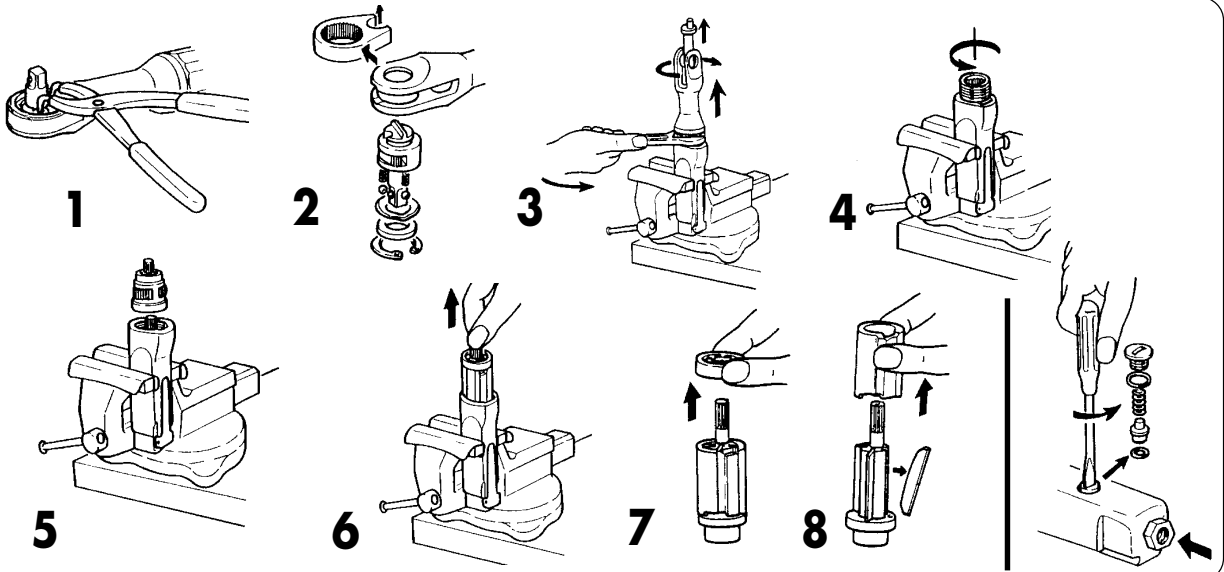
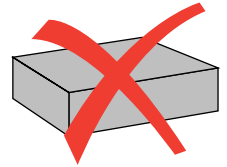

**V.950RN1**



	<b>V.950</b>		<b>V.950</b>		<b>V.950</b>
①	V.950RN1	⑪	V.950-044	⑳	ROOND.M8U
②	V.950SE1	⑫	V.950-049	㉑	ROOND.WW19 Onduflex "C"
③	V.950SE2	⑬	V.950-067	㉒	ROOND.M22U
④	V.950SE3	⑭	V.950-079	㉓	ROULEMENT.626
⑤	V.950SE4	⑮	ANNEAU.80-0290	㉔	ROULEMENT.608 (2)
⑥	V.950SE5	⑯	GROUP.E,1,5x8	㉕	ROULEMENT.6001
⑦	V.950SE6	⑰	GROUP.E,3x25	㉖	DOUILLE.RHNA121812
⑧	V.950-046J4	⑱	BAGUE.R00420-190	㉗	BILLE.RB-4 (2)
⑨	V.950-001	㉀	BAGUE.R00800-190	㉘	BILLE.RB-4,5
⑩	V.950-003	㉁	ROOND.M8U	㉙	AIGUILLE.RN-1,5x6,7 (22)

**BELGIQUE** FACOM Belgique S.A./NV  
**LUXEMBOURG** Weihoek 4  
1930 Zaventem  
BELGIQUE  
☎ : (02) 714 09 00  
Fax : (02) 721 24 11

**DANMARK** FACOM NORDEN A/S  
**FINLAND** Navervej 16B  
**ISLAND** 7451 SUNDS  
**NORGE** DANMARK  
**SVERIGE** ☎ : (45) 971 444 55  
Fax : (45) 971 444 66

**DEUTSCHLAND** FACOM GmbH  
Postfach 13 22 06   
42049 Wuppertal  
Otto-Wells-Straße 9   
42111 Wuppertal  
DEUTSCHLAND  
☎ : (0202) 270 63 0  
Fax : (0202) 270 63 50

**ESPAÑA** FACOM Herramientas SRL  
**PORTUGAL** Poligono industrial de Vallecas  
C/.Luis 1°, s/n-Nave 95 - 2°Pl.  
28031 Madrid  
ESPAÑA  
☎ : (91) 778 21 13  
Fax : (91) 778 27 53

**ITALIA** U.A. FACOM Italia  
Via Ronchetti 3  
21041 Albizzate (VA)  
ITALIA  
☎ : (0331) 985 811  
Fax : (0331) 985 930

**NEDERLAND** FACOM Gereedschappen BV  
Kamerlingh Onnesweg 2  
Postbus 134  
4130 EC Vianen  
NEDERLAND  
☎ : (0347) 372 334  
Fax : (0347) 376 020

**SINGAPORE** FACOM Tools FAR EAST Pte Ltd  
**FAR EAST** 15 Scotts Road  
Thong Teck Building #08.01.02  
Singapore 228218  
SINGAPORE  
☎ : (65) 732 0552  
Fax : (65) 732 5609

**SUISSE** FACOM S.A./AG  
**ÖSTERREICH** 12 route Henri-Stéphan  
**MAGYARORSZÁG** 1762 Givisiez/Fribourg  
**ČESKA REP.** SUISSE  
☎ : (4126) 466 42 42  
Fax : (4126) 466 38 54

**UNITED** FACOM Tools LTD  
**KINGDOM** Bridge Wharf - Bridge Road  
**EIRE** CHERTSEY - SURREY KT16-8LJ  
UNITED KINGDOM  
☎ : (01932) 566 099  
Fax : (01932) 562 653

**UNITED** FACOM TOOLS Inc.  
**STATES** 3535 West 47th Street  
Chicago Illinois 60632  
U.S.A.  
☎ : (773) 523 1307  
Fax : (773) 523 2103

**FRANCE** Société FACOM  
6-8, rue Gustave Eiffel B.P.99  
91423 Morangis cedex  
FRANCE  
☎ : 01 64 54 45 45  
Fax : 01 69 09 60 93  
<http://www.facom.fr>

