

**Pour votre sécurité
For your own safety
Zur eigenen Sicherheit
Voor uw veiligheid
Para su propia seguridad**

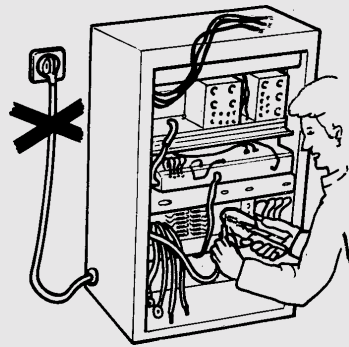
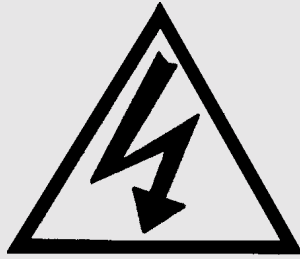

- Les produits à la marque FACOM ne sont pas destinés aux travaux sous tension. Pour ces travaux, se référer au programme FACOM ISOLE 1000 V - Norme EN 60900
- FACOM branded products are not intended for working on live components. For this type of application, refer to the FACOM 1000 V insulated range; Standard EN 60900
- Die Werkzeuge der Sparte FACOM sind für Arbeiten unter Spannung nicht geeignet. Bei Arbeiten unter Spannung empfiehlt sich das Programm FACOM-1000V ISOLIERT / Norm EN 60900
- De producten onder de merknaam FACOM uitgebracht, zijn niet bestemd voor het werken bij een spanningsbron. Hiervoor is geschikt het programma FACOM 1000V, norm EN 60900
- Los productos de la marca FACOM no están destinados a trabajos con voltaje. Para esos trabajos, véase el programa FACOM ISOLE 1000 V - Norma EN 60900

BELGIQUE FACOM Belgique S.A./NV
LUXEMBOURG Weihoek 4
1930 Zaventem - BELGIQUE
☎ : (02) 714 09 00 - fax : (02) 721 24 11

DANMARK FACOM
FINLAND Navervej 16B
ISLAND/NORGE 7451 SUNDS - DANMARK
SVERIGE ☎ : (45) 97 14 44 55- fax : (45) 97 14 44 66

DEUTSCHLAND FACOM GmbH
Postfach 13 22 06 ☐
42049 Wuppertal
Otto-Wels-Straße 9 ☐
42111 Wuppertal
DEUTSCHLAND
☎ : (0202) 270 63 0 - fax : (0202) 270 63 50

ESPAÑA FACOM Herramientas, S.L
PORTUGAL Poligono industrial de Vallecas
C/.Luis 1º s/n-Nave 95-2º Pl.
28031 Madrid - ESPAÑA
☎ : 91 778 21 13 - fax : 91 778 27 53

NEDERLAND FACOM Gereedschappen BV
Kamerlingh Onnesweg 2
Postbus 134
4130 EC Vianen - NEDERLAND
☎ : 31 347 362 362 - fax : 31 347 376 020

SINGAPORE FACOM TOOLS FAR EAST Pte Ltd
FAR EAST 15 Scotts Road
Thong Teck Building # 08.01.02
Singapore 228218 - SINGAPORE
☎ : (65) 732 0552 - fax : (65) 732 5609

SUISSE FACOM S.A./AG
ÖSTERREICH 12 route Henri-Stéphan
MAGYARORSZAG 1762 Givisiez/Fribourg - SUISSE
CESKA REP. ☎ : (4126) 466 42 42 - fax : (4126) 466 38 54

UNITED KINGDOM FACOM - UK
Churchbridge Works Walsall Road
EIRE CANNOCK STAFFORDSHIRE WS11 3JR - UNITED KINGDOM
☎ : (01922) 702 150 - fax : (01922) 702 152

UNITED STATES FACOM TOOLS Inc.
3535 West 47th Street
Chicago Illinois 60632 - U.S.A.
☎ : (773) 523 1307 - fax : (773) 523 2103

FRANCE Société FACOM
& 6-8 rue Gustave Eiffel BP.99
INTERNATIONAL 91423 Morangis Cedex - FRANCE
☎ : 01 64 54 45 45 - fax : 01 69 09 60 93
<http://www.facom.fr>

450.6P

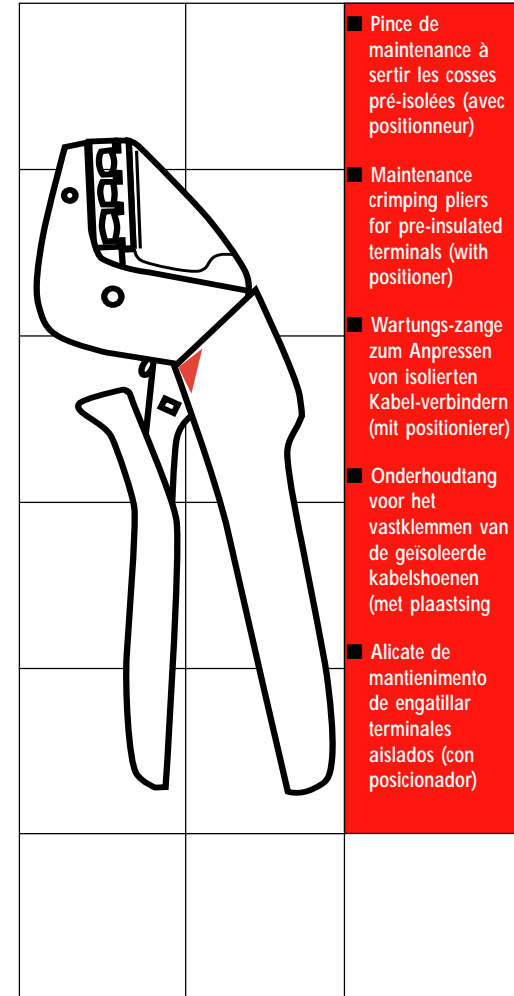

- Pince de maintenance à sertir les cosses pré-isolées (avec positionneur)
- Maintenance crimping pliers for pre-insulated terminals (with positioner)
- Wartungs-zange zum Anpressen von isolierten Kabel-verbindern (mit positionierer)
- Onderhoudtang voor het vastklemmen van de geïsoleerde kabelshoenen (met plaatsing)
- Alicates de mantenimiento de engatillar terminales aislados (con posicionador)

Notice d'instructions
Instruction manual
Bedienungsanleitung
Gebruiksaanwijzing
Manual de instrucciones

NU-450.6P/0102

FACOM

**Caractéristiques
Specifications
Kenndaten
Kenmerken
Características**

450.6P

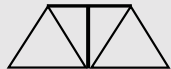

480 g.

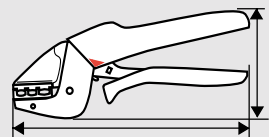

82 mm.

230 mm.

	Rouge Red Rot Rood Rojo	Bleu Blue Blau Blauw Azul	Jaune Yellow Gelb Geel Amarillo
	0,5 - 1,5 mm ²	1,5 - 2,5 mm ²	4 - 6 mm ²
AWG	20 - 16	16 - 14	12 - 10

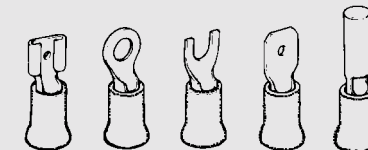

**Utilisation
Use
Bedienung
Gebruik
Utilizacion**

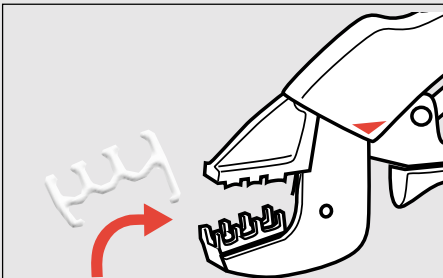

450.28

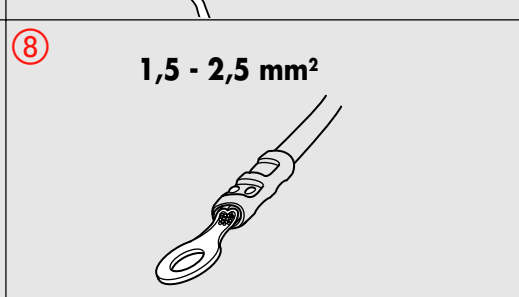
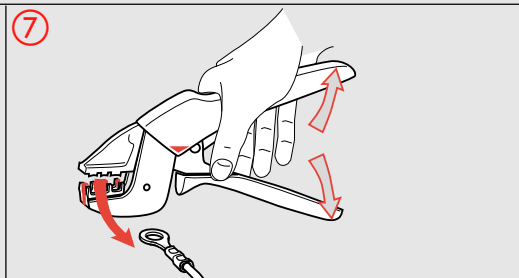
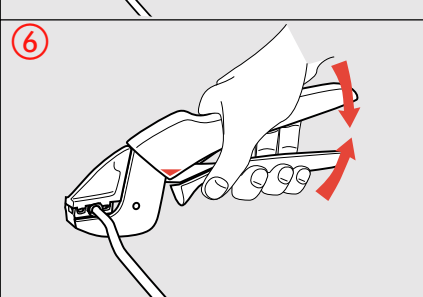
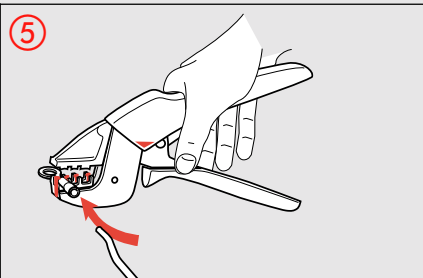
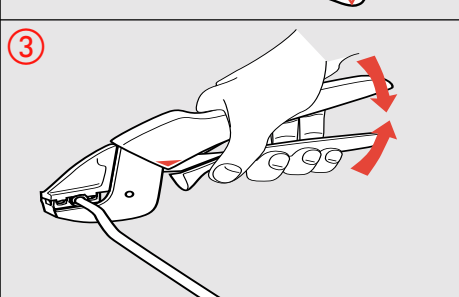
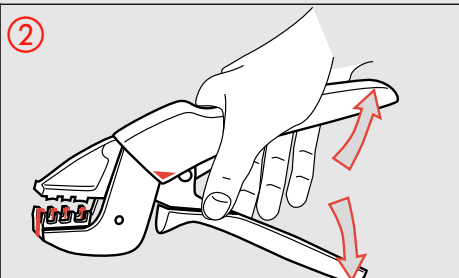
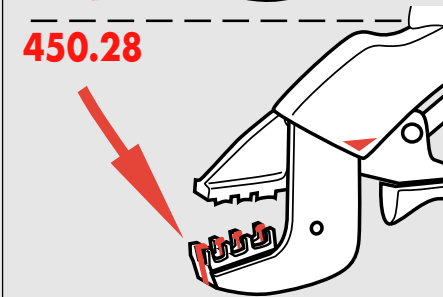

1,5 - 2,5 mm²

4 - 6 mm²

0,5 - 1,5 mm²

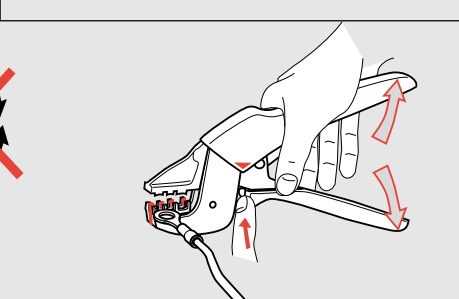
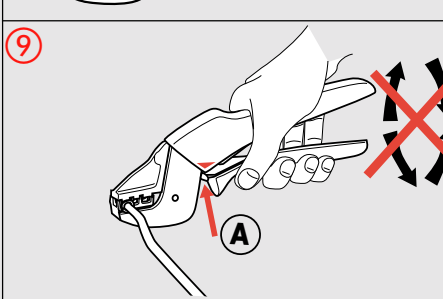
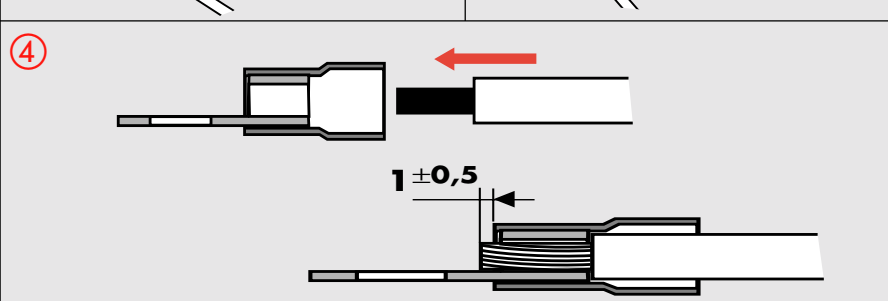
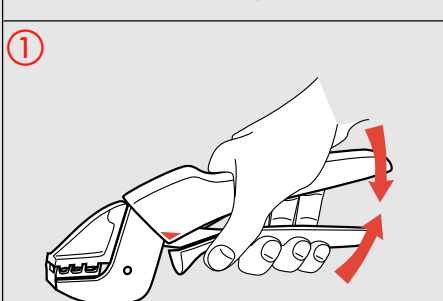

- En cas de blocage au cours du sertissage, il est possible de débrayer la pince en poussant le levier (A)
- Should the plier jam whilst crimping, it can be released by pressing lever (A)
- Falls die Zange während des Anpressvorgangs blockiert, Hebel (A) drücken, um die Zange zu lösen.
- In geval van een blokkering tijdens het zetten, is het mogelijk de tang te ontkoppelen door op de hendel (A) te drukken.
- En el caso de bloqueo durante el engatillado, es posible desembragar el alicata usando la palanca (A)